

KENWOOD

KDS-P110

DIGITAL SIGNAL PROCESSOR ▶ Page 2-37

INSTRUCTION MANUAL

PROCESSEUR DE SIGNAL NUMERIQUE ▶ Page 38-73

MODE D'EMPLOI

DIGITAL SIGNAL PROCESSOR ▶ Page 74-109

BEDIENUNGSANLEITUNG

KENWOOD CORPORATION

Contents

Before use

Safety precautions	3
Features	4
Before using the KDS-P110	9

Volume section

Volume	10
Dynamic range control	11

Sound field controller section

Sound field KBS	12
Sound field controller	14
Voice emphasis	16
Position control	18

Parametric equalizer section

Parametric equalizer KBS	20
Auto parametric equalizer	22
Manual parametric equalizer	24

Other features

Non-Fading preout	26
DSP memory	27
Display control	28
Balance / Fader control	30
Selectable illumination	31

Installation

Accessories	32
Installation procedure	33
Connection	34
Installation	35

Troubleshooting guide	36
-----------------------------	----

Specifications	37
----------------------	----

Safety precautions

▲WARNING

Take the following precautions to prevent fire and avoid personal injury :

- When extending the power supply cable, memory backup cable, or ground cable, use 0.75mm² (AWG18) or larger automotive grade cable to avoid cable deterioration or damage to the covering.
- Check that no metal objects (coins, tools, etc.) are left inside the unit to avoid short circuits.
- If you smell or see smoke, turn the power off immediately and consult your Kenwood dealer.

▲CAUTION

Take the following precautions to keep the unit in proper working order.

- Be sure the unit is connected to a 12V DC power supply with a negative ground connection.
- Do not open the top or bottom cover.
- Do not install the unit in places it is exposed to direct sunlight, high heat or humidity, water may splash over it, or dust exists.
- If you need to replace the fuse, make sure the new fuse is of the same type and rating. Using a fuse of a different type of rating may damage your unit. The fuse rating is normally shown on the fuse and fuse box.

NOTE

- If you have difficulty in installing this unit in your vehicle, contact your Kenwood dealer.
- If it doesn't seem to be working properly, first press the Reset button. If the malfunction persists, consult your Kenwood dealer.



Reset button

- Always use a four-speaker system (front and rear) with this unit, to enjoy the DSP effects.

Cleaning the unit

- If the front panel is dirty, wipe it clean with a silicon cloth or soft dry cloth with the power off.

▲CAUTION

Do not use hard cloths or paint thinner, alcohol, or other volatile solvents. These may damage external surfaces or remove indicator characters.

FCC WARNING

- This equipment may generate or use radio frequency energy. Changes or modifications to this equipment may cause harmful interference unless the modifications are expressly approved in the instruction manual. The user could lose the authority to operate this equipment if an unauthorized change or modification is made.

Before use

Features

Before use

■ Volume section

Music cannot be clearly heard due to road noise.

• Dynamic range compression control (Page 11)

The differences in music sound level (dynamic range) can be reduced by this function (dynamic range compression). Since the function makes quiet sounds louder than usual, you can clearly hear the quiet sounds that are drowned out by road noise. The function is effective when listening to classical music containing long quiet passages. But it has little effect when you listen to pops in which loud sound predominates.

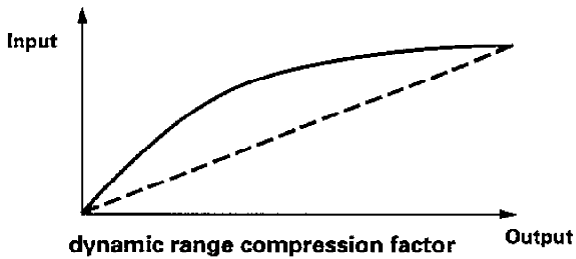

Making sound punchier.

• Dynamic range expansion control (Page 11)

The differences in music sound level (dynamic range) can be increased by this function (dynamic range expansion). The function makes loud sounds louder, so the attack of musical instruments is emphasized and the music is better modulated and smoothed. The function is useful when listening to pops and so on.

Dynamic range compression and expansion can be adjusted in three levels.

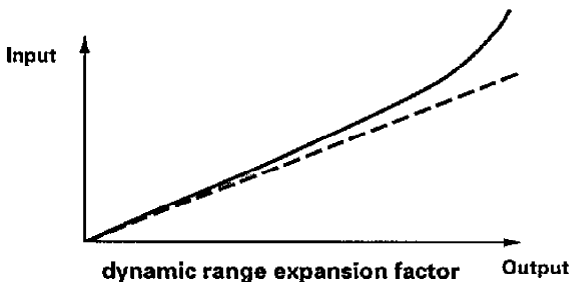

■ Sound field controller section

Creating your favorite acoustic space in your car.

• Sound field controller (Page 14)

You can create a desired sound field by adjusting the five parameters described below.

Selecting the listening room size.

Room size

You can choose one of nine rooms, ranging from a small room about 3 meters square to a concert hall seating 500 people.

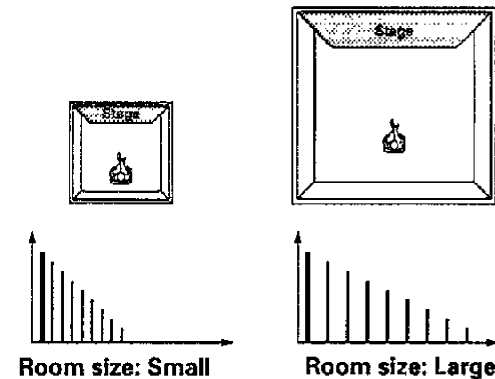

Selecting the listening room structure

Liveness

The reflected sound level can be adjusted in the range 50% to 100%. Changing this parameter has the same effect as changing the wall, floor, or ceiling structure. As the parameter value increases, the reflected sound level increases, and reverberation, intensifying.

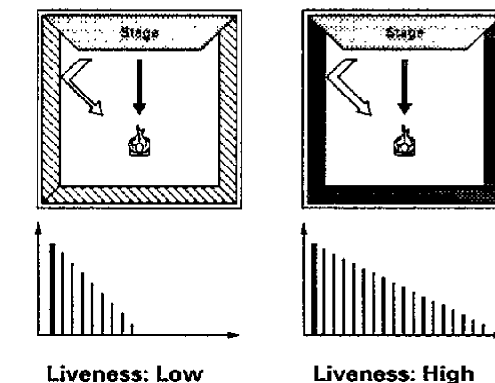

Determining the reverberation level and time.

Effect level

The initial reflected sound level and reverberation level can be adjusted in the range zero to 100%. When this parameter is increased, the reverberation level increases and the reverberation time is lengthened. The effect level is the most important parameter for the Sound field controller. The sound field may become better or worse depending on how the function is adjusted.

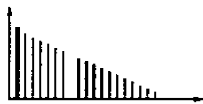

Effect level: High

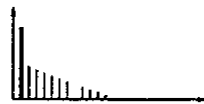

Effect level: Low

Adjusting reverberation.

Reverberation level

Reverberation time is generally determined by the room size and liveness (as the room size increases, the interval between reflected waves increases and the reverberation time increases; as the liveness value increases, attenuation decreases and the reverberation time increases). This parameter can reduce the reverberation level to make sources containing much reverberation easy to hear or adjust the reverberation time determined by the structure or interior of your car to the optimum value. It can be adjusted in the range zero to 100%.

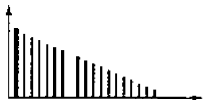

Reverberation level: High

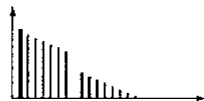

Reverberation level: Low

Selecting wall material.

Cut-off frequency of reflected sound

Sounds with frequencies above a certain level are reduced by the material of the walls on which they reflect. This phenomena can be simulated by changing the cut-off frequency of the reflected sound. The range of reflected sounds to be reduced can be set in the range 800 Hz to 16 kHz. When the cut-off frequency of the reflected sound is reduced to eliminate high-frequency components from the reverberation, it sounds overwhelmed with bass.

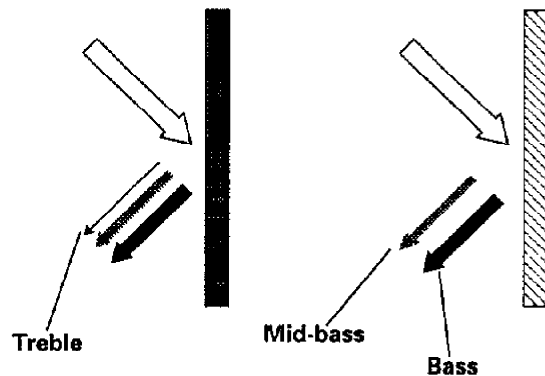

Features

Before use

Making vocal localization clear.

- **Voice emphasis (Page 16)**

When the room size increases, vocals sound far away. If this function is turned on, the vocal sound and bass are emphasized and can be heard more clearly.

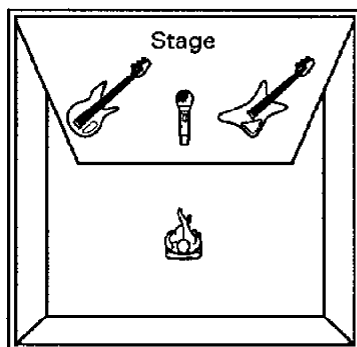

OFF

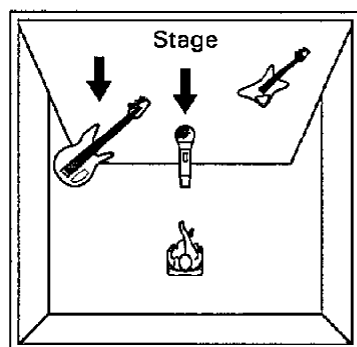

ON

Using the Sound field controller function without complicated operation.

- **Sound field KBS (Kenwood Built-in Sound) (Page 12)**

Some sets of values for room size, liveness, effect, reverberation level, and cut-off frequency of reflected sound are preset in memory. The sound fields of three kinds of room, including a small jazz club and a small concert hall, are stored in memory. These values may be used as a reference for the Sound field controller by recalling Sound field KBS and then adjusting the values.

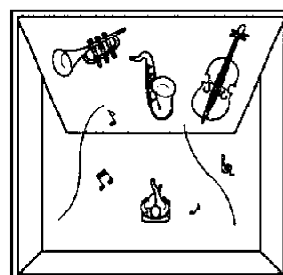

ROOM B
(Small jazz club)

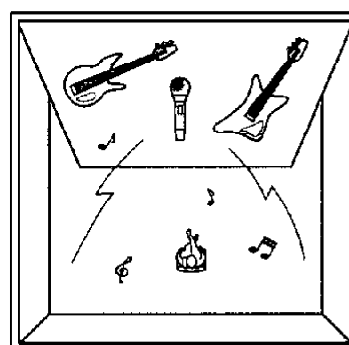

ROOM C
(Small concert hall)

Maximizing the DSP effect around you.

- **Position control (Page 18)**

The listener position can be adjusted to maximize the DSP effect for the listener.

■ Parametric equalizer section

Digital equalizing.

- **Manual parametric equalizer (Page 24)**

You can select and adjust the center frequencies for four bands from a selection of 25 frequencies, as well as the gains and quality factors for the bands. The KDS-P110 combines the four adjusted bands to produce a smooth equalizer curve.

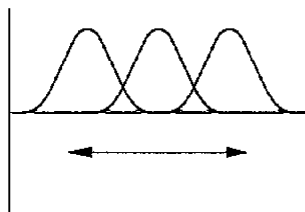

Center frequencies adjustment

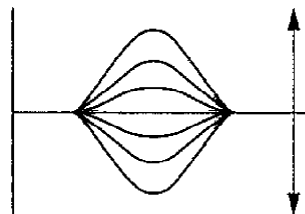

Gain adjustment

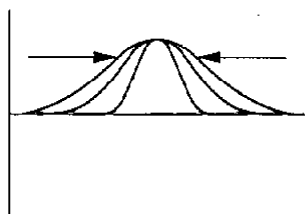

Quality factor adjustment

Using the digital equalizer like a conventional graphic equalizer.

- **Automatic parametric equalizer (Page 22)**

You just adjust the graphic equalizer for 9 bands. The KDS-P110 then calculates and sets the center frequencies, gains, and quality factors for the four bands to match as closely as possible the graphic equalizer curve of the 9 bands. Some knowledge and experience is needed to predict and adjust the result of synthesis of the four bands using the Manual parametric equalizer function. However, if the Automatic parametric equalizer function is used, you can carry out parametric equalizer adjustment easily in the same way as with a conventional graphic equalizer.

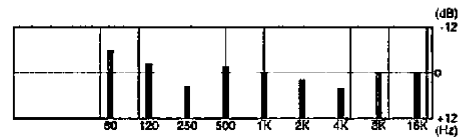

Graphic equalizer adjustment

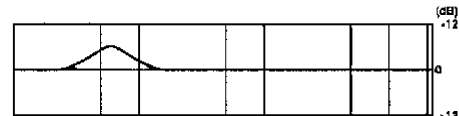

Development of band 1

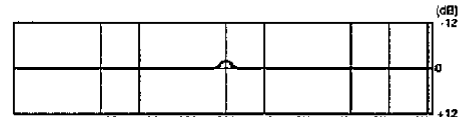

Development of band 2

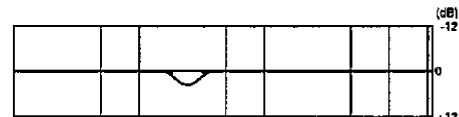

Development of band 3

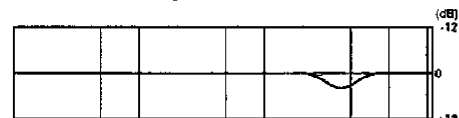

Development of band 4

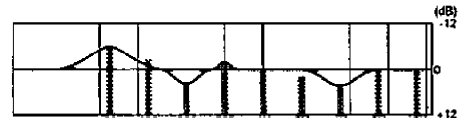

Combined curve of band 1 to 4

Features

Before uses

Using the digital equalizer more easily

- **Parametric equalizer KBS (Kenwood Built-in Sound) (Page 20)**

Six sets of Parametric equalizer settings for different kinds of music are preset in memory. You can use the Parametric equalizer just by recalling the desired settings.

■Other feature section

Three preout systems.

- **Non-Fading preout (Page 26)**

The KDS-P110 not only has front and rear preout systems, but also a Non-fading preout. The Non-fading preout volume is adjusted by setting the difference between the preout level and the main volume level. So, sound of appropriate level is always output regardless of how the volume is adjusted.

Presetting various settings.

- **DSP Memory (Page 27)**

Combinations of Dynamic range, Sound field controller, Position, Parametric equalizer, and Non-fading preout level can be put in memory and recalled at the touch of a button.

- **Balance/Fader controls (Page 30)**

Adjust the balance and fader.

- **Selectable illumination (Page 31)**

Allows illumination colour to be switched between green and orange.

Before using the KDS-P110

Before use

When using the Sound field controller function

Before starting Sound field control, set the Sound field controller function to Bypass, the Position control function to All, the Equalizer function to OFF (Flat), and adjust the power amplifier input sensitivity control or fader control to make the sound levels of the front and rear speakers equal. If the Sub-woofer volume is higher than the rear speaker level, the Sound field controller may have little effect.

"OVER" display

Normally, set the center unit volume control to maximum and adjust the volume using the KDS-P110. However, if a source with a high recording level is used or if a center unit with a high output level is connected, it is necessary to adjust the center unit volume and KDS-P110 parameters.

If the KDS-P110 input or output is excessive, "OVER" is displayed and sound may be distorted. In this case, follow steps 1 to 3.

Step 1

Cause

The center unit output is high.

Remedy

Reduce the center unit volume until "OVER" disappears.

Step 2

Cause

Each frequency level of the equalizer is set to maximum (+12 dB).

Remedy

Reduce the equalizer level. (Use the optimum value.)

Step 3

Cause

The Dynamic range level is set to minimum (-3).

Remedy

Do one of the following:

1. Set Dynamic range to OFF.
2. Reduce Dynamic range to -1 and set Voice emphasis to OFF.
3. Reduce the Dynamic range to -1 and decrease the Effect level.

Volume

Volume section

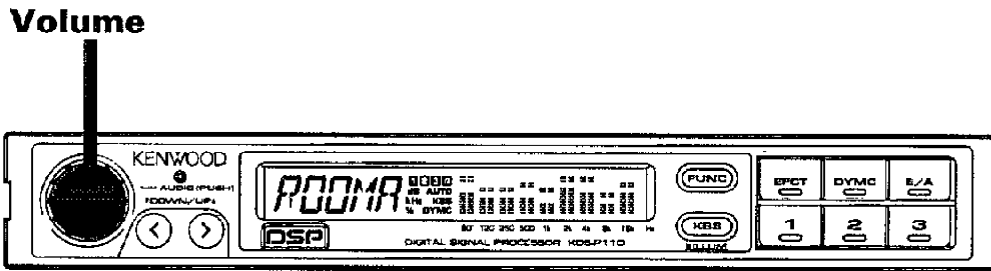

To increase the volume

Turn the Audio controller clockwise.
The current volume is displayed in decibels.



To decrease the volume

Turn the Audio controller counterclockwise.
The current volume is displayed in decibels.



When the volume is set to minimum, "--" is displayed.

NOTE

- Set the volume control of the center unit to maximum and adjust the volume of the KDS-P110. If the input from the center unit is too high, "OVER" is displayed and the sound may be distorted. In this case, see page 9 and take appropriate action.
- The volume can be adjusted only in normal mode (all special modes canceled).

Dynamic range control

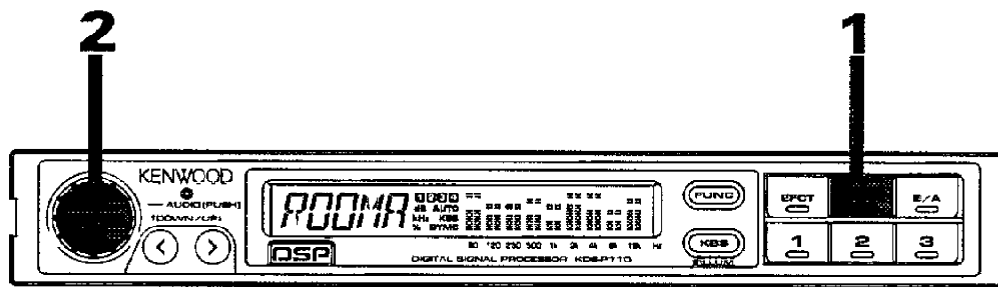

Volume section

- 1** Turn Dynamic range control on. Press the DYMC button. "DY" is displayed and Dynamic range control turns on. The DYMC indicator stays lit while Dynamic range control is on.

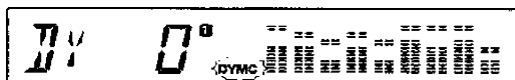

NOTE

The Dynamic range can be controlled only in normal mode. Cancel all other modes.

- 2** To compress the Dynamic range

Turn the Audio controller counterclockwise. The current Dynamic range is displayed. It can be adjusted to -3.

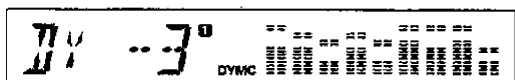

To expand the Dynamic range
Turn the Audio controller clockwise. The current Dynamic range is displayed. It can be adjusted to +3.

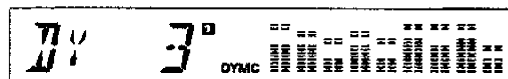

NOTE

If you compress the Dynamic range when you hear a lot of noise due to poor radio reception, the noise level increases and it becomes difficult to listen to the radio. In this case, turn Dynamic range control off.

To cancel

Press the DYMC button. "DY OFF" is displayed and Dynamic range control turns off. The DYMC indicator goes off.

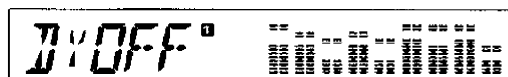

Sound field KBS

Audio controller

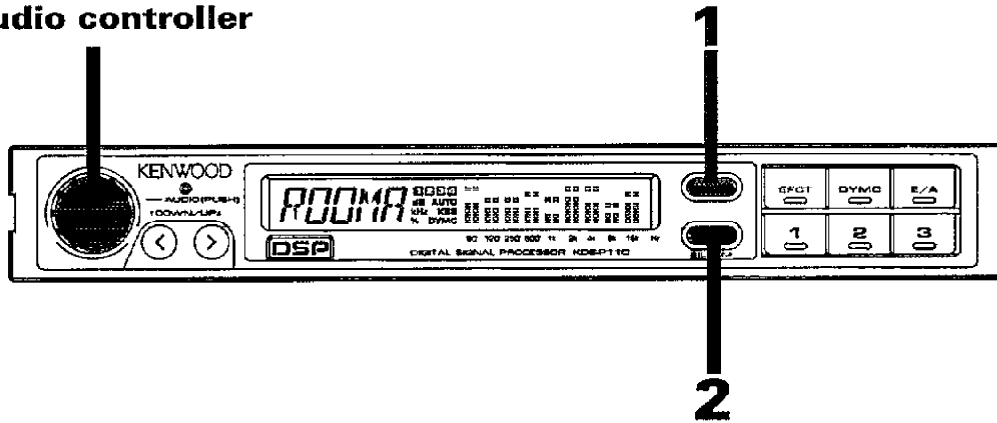

Sound field controller section

- 1** To enter Sound field controller mode
Briefly press the FUNC button. "SFC" is displayed and Sound field controller mode is entered. If you don't do anything within the next 10 seconds, the mode is automatically exited.

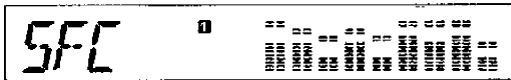

- 2** To select an acoustic setting
Briefly press the KBS button. Each time the button is pressed, the setting changes from Room A to Room B to Room C to OFF and back to Room A.



NOTE

If the Sound field controller is set to Bypass, Sound field KBS cannot be used.

To cancel

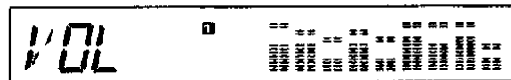
Press the Audio controller for more than a second or press the FUNC button five times. "VOL" is displayed and normal mode returns.



Parameter \ ROOM	ROOM A	ROOM B	ROOM C	OFF
Display	<i>ROOMA</i> 	<i>ROOMB</i> 	<i>ROOMC</i> 	<i>OFF</i>
Image	Room slightly larger than the passenger compartment	Small jazz club	Small concert hall	Return to the settings that were valid before Sound field KBS was turned on.
Room size	1	5	8	
Liveness	80	80	70	
Effect level	80	60	60	
Reverberation time	60	100	100	
Cut-off frequency of reflected sound	8 kHz	8 kHz	8 kHz	

You can select a room other than Room A, B, or C by changing the parameters as follows:

Parameter \ ROOM	ROOM A'	ROOM B'	ROOM C'
Image	Small room with emphasized reverberation	Small jazz club with emphasized reverberation	Small concert hall with emphasized reverberation
Room size	1	5	8
Liveness	100	100	80
Effect level	100	100	100
Reverberation time	0	40	80
Cut-off frequency of reflected sound	8 kHz	16 kHz	8 kHz

Sound field controller

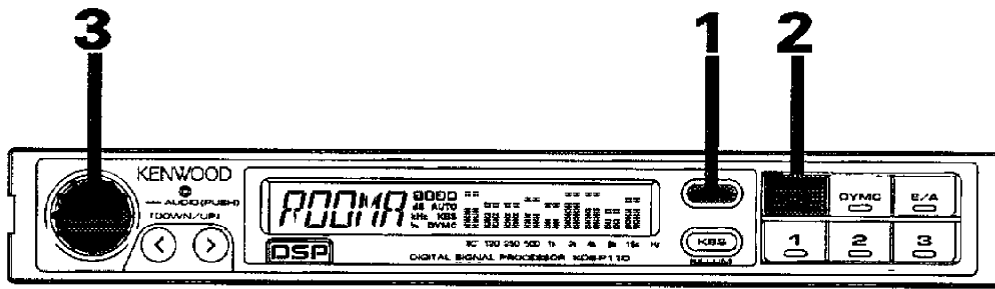

Sound field controller section

- 1** To enter Sound field controller mode
Briefly press the FUNC button. "SFC" is displayed and Sound field controller mode is entered. If you don't do anything within the next 10 seconds, the mode is automatically exited.

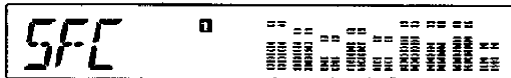

- 2** To select a control parameter
Press the EFCT button. Each time the button is pressed, the adjustable parameter changes in the order shown in the table below.

- 3** To adjust parameters
Turn the Audio controller. Adjust the parameters according to the following table.









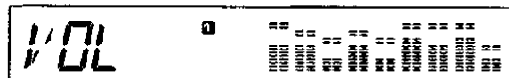

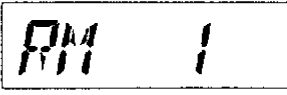
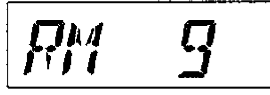

NOTE

The standard reverberation level is 60%. If the reverberation lasts too long, decrease the level; if it does not last long enough, increase the level.

To cancel

Press the Audio controller for more than a second or press the FUNC button five times. "VOL" is displayed and normal mode returns.

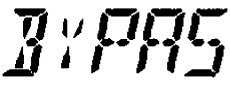

Operation Parameter	Audio controller		Standard value
	Turn counterclockwise	Turn clockwise	
Room size 	Size down Adjustable to size 1. 	Size up Adjustable to size 9. 	—
Liveness 	Level down Adjustable to 50%. 	Level up Adjustable to 100%. 	80 %
Effect level 	Level down Adjustable to 0%. 	Level up Adjustable to 100%. 	80 %
Reverberation level 	Level down Adjustable to 0%. 	Level up Adjustable to 100%. 	60 %
Cut-off frequency of reflected sound 	Frequency down Adjustable to 800 Hz. 	Frequency up Adjustable to 16 kHz. 	16 kHz
Bypass 	—	—	—

Sound field controller section

Voice emphasis

Audio controller

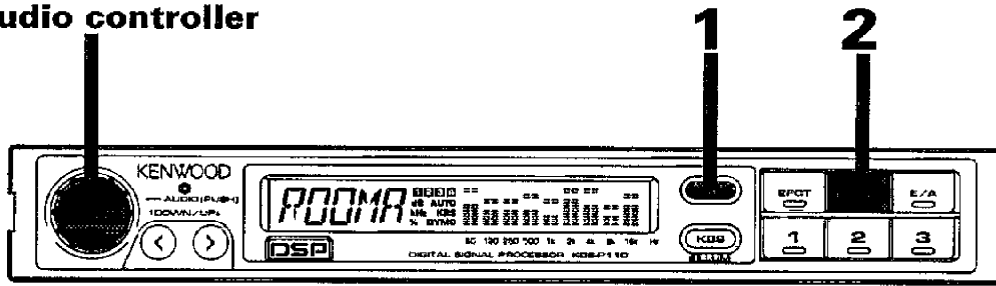

- 1** To enter Sound field controller mode
Briefly press the FUNC button. "SFC" is displayed and Sound field controller mode is entered. If you don't do anything within the next 10 seconds, the mode is automatically exited.

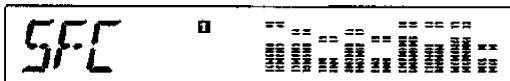

- 2** To use Voice emphasis
Press the DYMC button. Each time the button is pressed, Voice emphasis turns on or off.

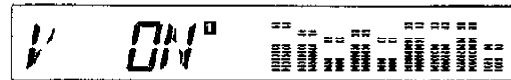

ON

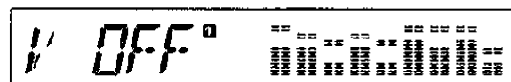

OFF

NOTE

If the Sound field controller is set to Bypass, Voice emphasis cannot be used.

To cancel

Press the Audio controller for more than a second or press the FUNC button five times.
"VOL" is displayed and normal mode returns.

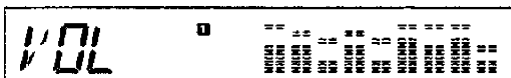

Position control

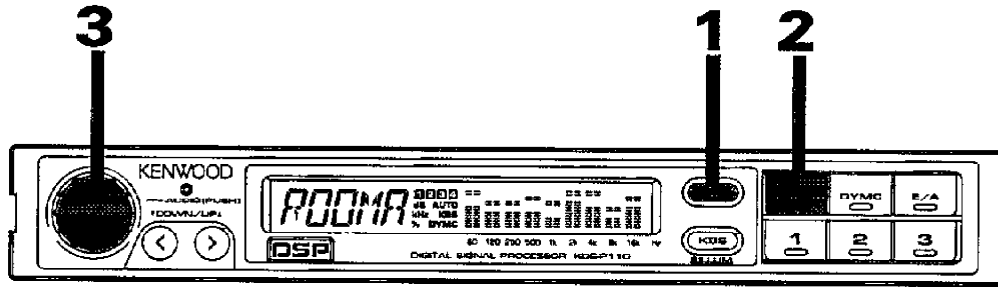

Sound field controller section

- 1** To enter Position control mode
Press the FUNC button four times.
"POSI" is displayed and Position control mode is entered. If you don't do anything within the next 10 seconds, the mode is automatically exited.

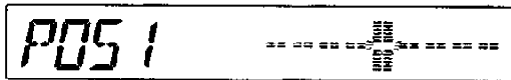

- 2** To select a position
Press the EFCT button.
Each time the button is pressed, the position changes in the order shown in the table on the right.

NOTE

The position control does not emphasize the sound at the selected position, but produces the best DSP effect for that position.

- 3** To fine-adjust the position
Turn the Audio controller.
When the Audio controller is turned clockwise, the position is fine-adjusted clockwise; when the control is turned counterclockwise, the position is fine-adjusted counterclockwise.

NOTE

When the position is set to "ALL", it cannot be fine-adjusted.

To cancel

Press the Audio controller for more than a second or press the FUNC button twice.
"VOL" is displayed and normal mode returns.

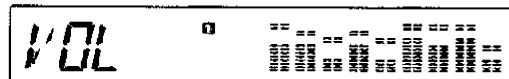

■ Position selection

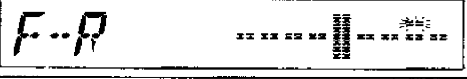
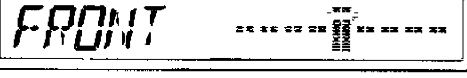
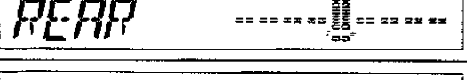
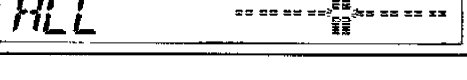
Position	Position display
Front left	
Front right	
Front all	
Rear all	
All	

■ Example of position fine-adjustment display: When Front Right is fine-adjusted

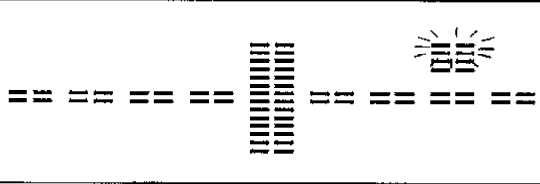
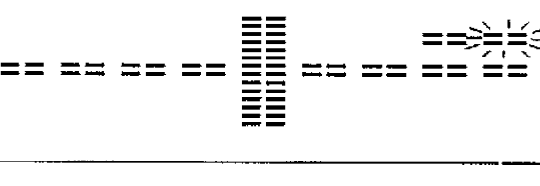
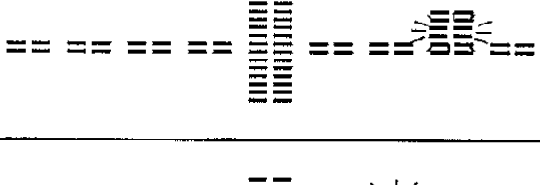
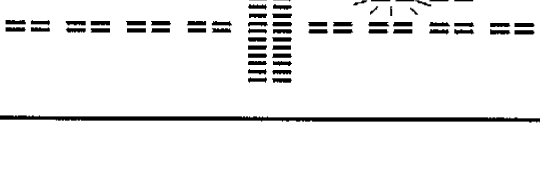
Position fine-adjustment	Display
Front	
Right	
Rear	
Left	

Parametric equalizer KBS

Audio controller

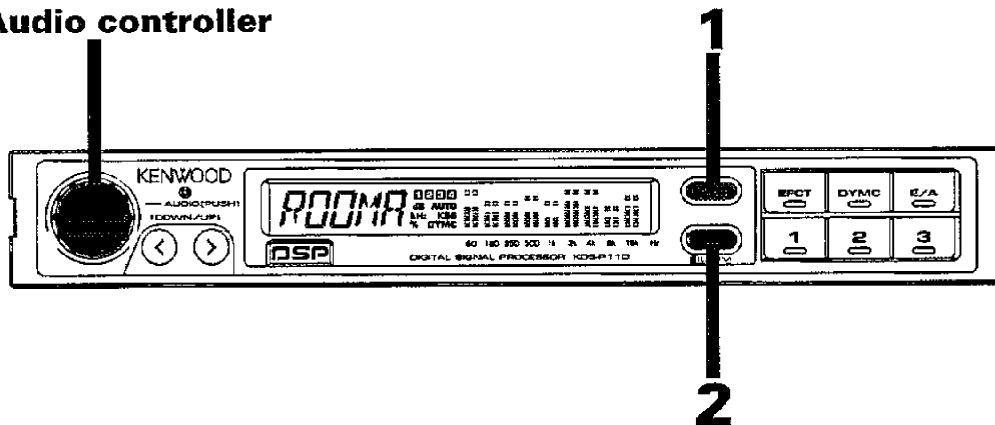

Parametric equalizer section

- 1** To enter Parametric equalizer mode
Press the FUNC button twice (or three times).
"EQ-AT" (or "EQ-MN") is displayed and Automatic parametric equalizer mode (or Manual parametric equalizer mode) is entered. If you don't do anything within the next 10 seconds, the mode is automatically exited.

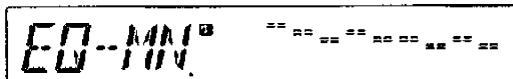
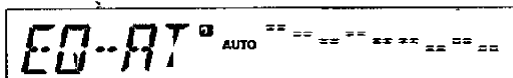

- 2** To select an equalizer curve
Briefly press the KBS button.
Each time the button is pressed, the equalizer curve changes in the order shown on the facing page.

- To cancel**
Press the Audio controller for more than a second or press the FUNC button four (or three) times.
"VOL" is displayed and normal mode returns.

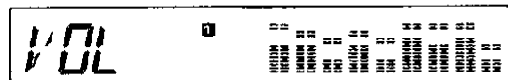

■ EQUALIZER CURVES

The following preset digital equalizer curves are available. Pick the one you prefer; the name are suggestions only.

1. LOUDNESS

Reproduces a crisp sound by enhancing the high and low frequencies. Effective when listening at a low volume.

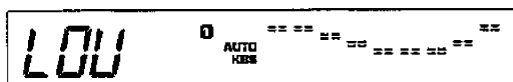

4. VOCAL

Emphasizes the human vocal range, intensifies the vocal coloration for greater immediacy.

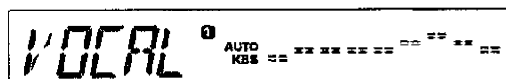

2. POPS

Adds modulations to instrumental and vocal music.

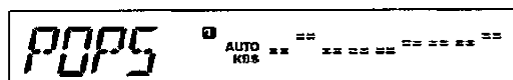

5. CLASSIC

Ideal for reproducing full orchestral sound; pyramidal structure with contrabass as base.

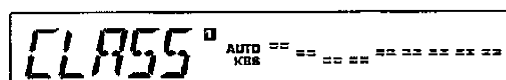

3. ARENA

Reproduces a live-performance feel and the distinctive sound of each instrument in a large ensemble. Also effective when listening to all sources in the background.

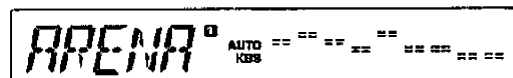

6. Equalizer OFF (Flat)

No equalizer effect, for the natural sound.

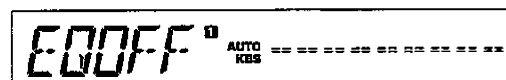

7. KBS OFF

Uses the equalizer curve set before turning KBS on.

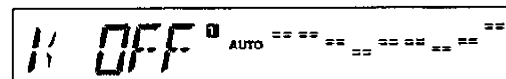

Auto parametric equalizer

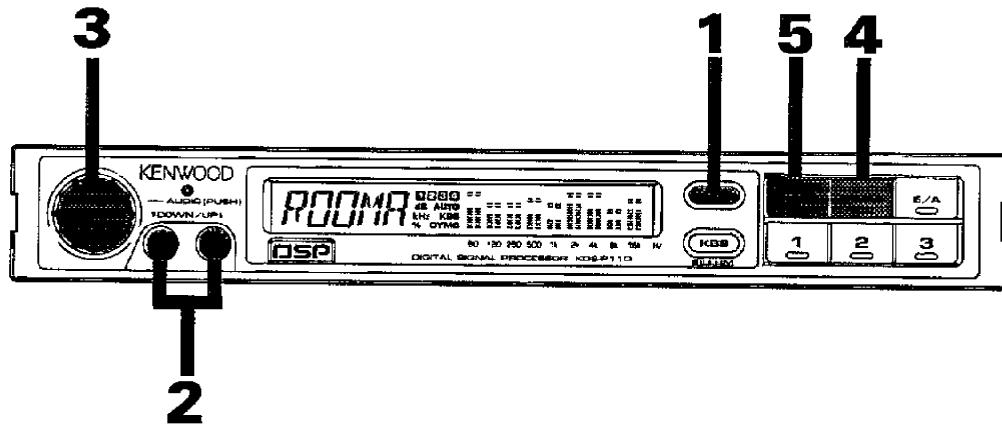

Parametric equalizer section

- 1** To enter Automatic parametric equalizer mode
Press the FUNC button twice.
"EQ-AT" is displayed and Automatic parametric equalizer mode is entered.
If you don't do anything within the next 10 seconds, the mode is automatically exited.

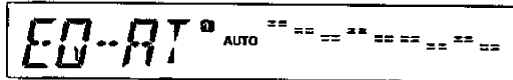

- 2** To select a setting frequency
Press the < or > button.
The flashing setting frequency can be adjusted.
When the < button is pressed, the setting frequency shifts to the left (decreases); when the > button is pressed, the setting frequency shifts to the right (increases).



- 3** To increase the setting level
Turn the Audio controller clockwise.
The setting level increases. The parameter of the band produced in the parametric equalizer is displayed on the left.



- To decrease the setting level
Turn the Audio controller counterclockwise.
The setting level decreases.

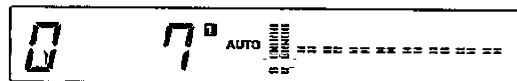

NOTE

If the setting cannot be implemented by four bands, the equalizer curve that is closest to the setting for the four bands is created.

- 4** To switch the produced band display
 Press the DYMC button.
 Each time the button is pressed, the values (Center Frequency, Gain, or Quality Factor) produced for the parametric equalizer change from band 1 to band 2 to band 3 to band 4 and back to band 1.

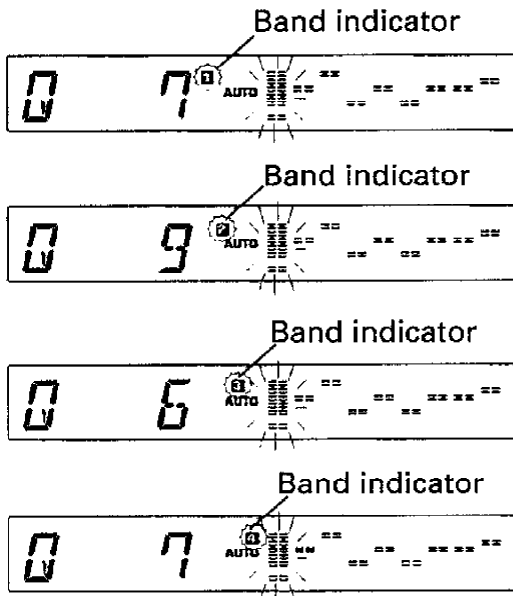

- 5** To switch produced parameter display
 Press the EFCT button.
 Each time the button is pressed, the display of the band selected in step 4 changes from Center Frequency to Gain to Quality Factor and back to Center Frequency.

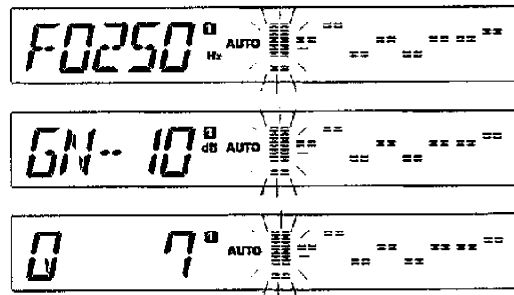

NOTE

You can see the equalizer curve produced by the parametric equalizer by pressing the E/A button to display the curve.

To cancel

Press the Audio controller for more than a second or press the FUNC button four times.
 "VOL" is displayed and normal mode returns.

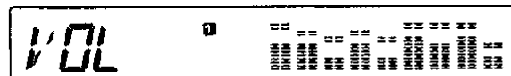

Manual parametric equalizer

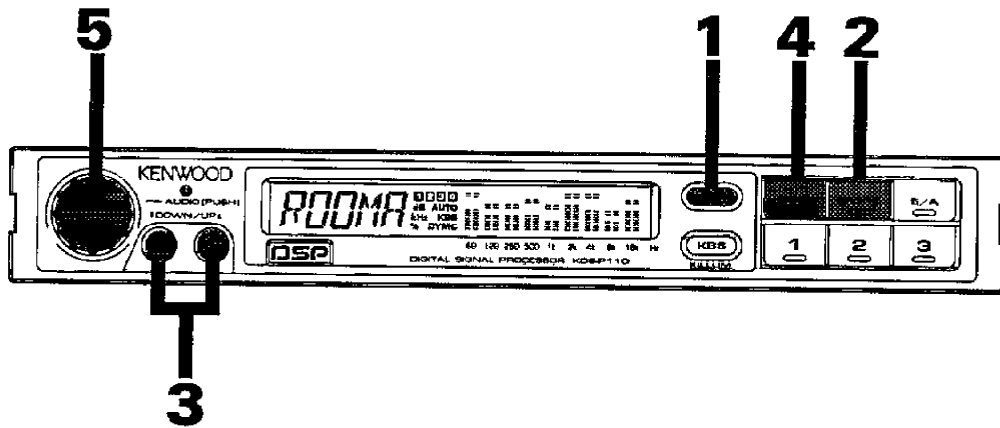

Parametric equalizer section

- 1** To enter Manual parametric equalizer mode
Press the FUNC button three times. "EQ-MN" is displayed and Manual parametric equalizer mode is entered. If you don't do anything within the next 10 seconds, the mode is automatically exited.

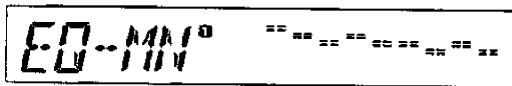

- 3** To select the center frequency for the equalizer
Press the < or > button.
The center frequency can be selected from the following 25 frequencies: 60, 75, 96, 120, 150, 200, 250, 320, 400, 500, 620, 700, 800, 1k, 1.2k, 1.6k, 2k, 2.5k, 3.2k, 4k, 5k, 6.4k, 8k, 10k, and 16k Hz.



- 2** To select a band to be adjusted
Press the DYMC button.
Each time the button is pressed, the band changes from band 1 to band 2 to band 3 to band 4 and back to band 1.
The current band is indicated by the band indicator.

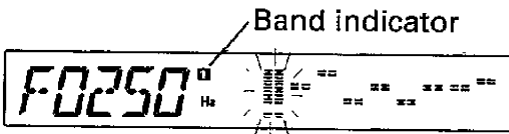

- 4** To select a parameter to be adjusted
Press the EFCT button.
Each time the button is pressed, the band switches between Quality Factor adjustment and Gain adjustment.



5 To adjust the parameter
Turn the Audio controller.
Adjust the parameter according to the following table.

NOTE

The gain can be adjusted in the range -12 to +12 dB. If it reaches -12 or +12 dB as a result of synthesizing the gains of all the bands, the parameter cannot be adjusted any further. However, it can be adjusted if the gain of an adjacent band is decreased, one center frequency is moved away from another, or the quality factor is increased.

To cancel

Press the Audio controller for more than a second or press the FUNC button three times.
"VOL" is displayed and normal mode returns.

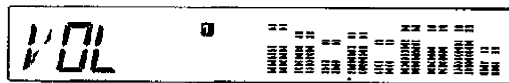

Parameter \ Operation	Audio controller	
	Turn counterclockwise	Turn clockwise
Quality factor	Quality factor down Adjustable to level 1.	Quality factor up Adjustable to level 9.
Gain	Gain down Adjustable to -12 dB in 2-dB steps.	Gain up Adjustable to +12 dB in 2-dB steps.

Non-Fading preout

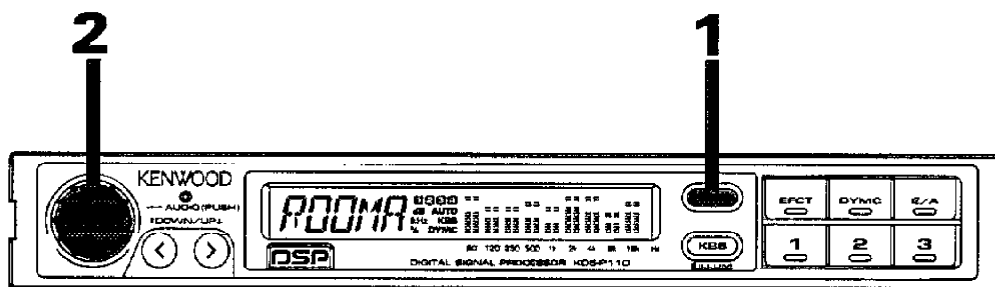

- 1 To enter Non-fading preout mode**
 Press the FUNC button five times. "N-F" is displayed and Non-fading preout mode is entered. If you don't do anything within the next 10 seconds, the mode is automatically exited.

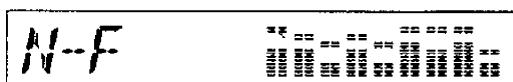

NOTE

The Non-fading preout output is mono.

- 2 To increase the preout level**
 Turn the Audio controller clockwise.
 The preout level can be adjusted to +10 dB. The difference between the preout level and the current main volume level is displayed.

To decrease the preout level
 Turn the Audio controller counterclockwise.
 The preout level can be adjusted until the sound ceases.
 The total of the preout level and the main volume level cannot be below -80 dB. If it reaches -80 dB, the preout level cannot be reduced any further. The difference between the preout level and the current main volume level is displayed.

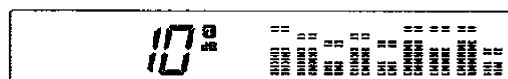

NOTE

The Non-fading preout level is set as the difference between the preout level and the main volume level.

To cancel
 Press the Audio controller for more than a second or press the FUNC button once.
 "VOL" is displayed and normal mode returns.

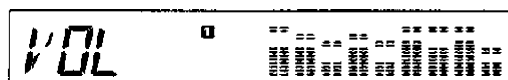

Other feature section

DSP memory

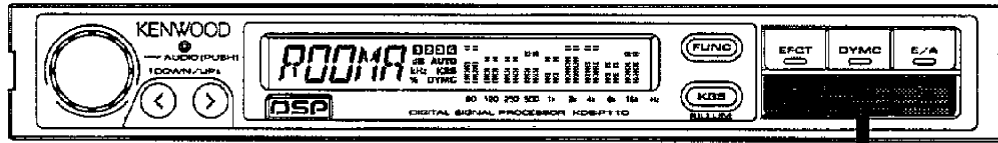

2,3

1

Set a combination of Dynamic range, Sound field controller, Position, Parametric equalizer, and Non-fading preout level to be stored in memory.

2

Hold down a Preset button (1-3) for more than 2 seconds. When the settings have been stored in memory, the number of the pressed button flashes once.



3

To recall DSP settings stored in memory

Briefly press the Preset button used to store the settings in memory. The number of the pressed button is displayed and the DSP settings stored in memory are recalled.

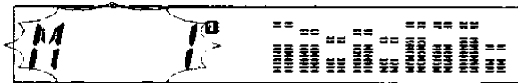

Other feature section

Display control

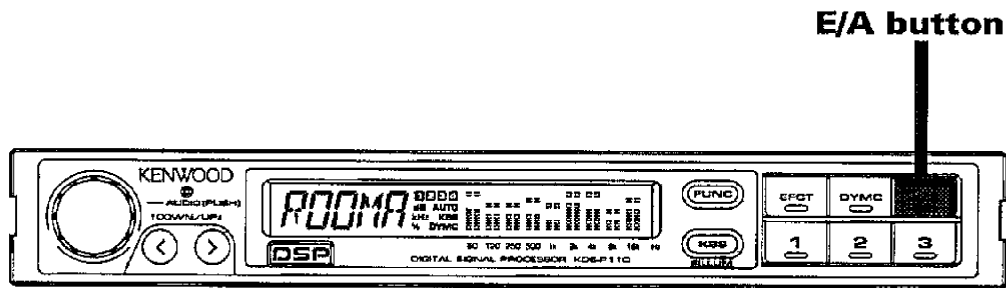

To select display

Press the E/A button.

Each time the E/A button is pressed, the display switches to the next display type in the sequence 1 to 6 shown below.

NOTE

If the E/A button is pressed to change the display while in Automatic parametric equalizer mode, Manual parametric equalizer mode, Position control mode, Balance control, or Fader control, the current mode is automatically exited.

1. Equalizer curve display

The adjusted equalizer curve is displayed.

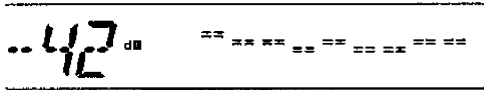

4. Semi-twin spectrum analyzer display

If the spectrum analyzer level increases, the portion exceeding the center line is divided into two parts, which are displayed vertically.

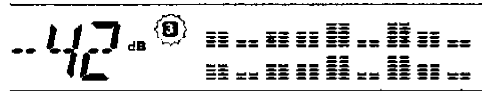

2. Peak hold spectrum analyzer

The spectrum analyzer with peak hold function displays the level of each band.

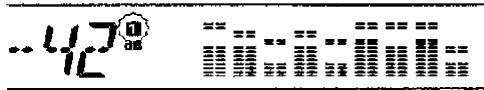

5. Half reversed spectrum analyzer display

The spectrum analyzer level below the center line is displayed in reverse video, and the level above the center line is displayed normally.

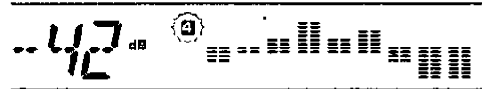

3. Aurora

An auroral waveform curve is displayed.



6. Scan

Each of displays 1 to 5 in succession is shown for 5 seconds.

Other feature section

Balance/Fader control

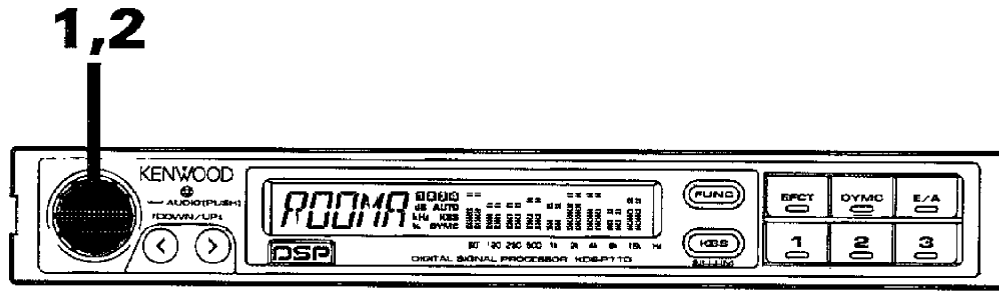

1 To select a control parameter
Briefly press the Audio controller.
Each time the controller is pressed, it becomes possible to adjust the Balance, then the Fader, and back to the Volume.

2 To adjust the parameter
Turn the Audio controller.
Adjust the parameter according to the following table.

NOTE

To prevent reduction of DSP effects, if you set the position to anything other than ALL, Balance control cannot be effected.

Other feature section

Operation Display	Audio controller	
	Turn counterclockwise	Turn clockwise
<p>Balance control</p>	<p>The left sound is boosted.</p>	<p>The right sound is boosted.</p>
<p>Fader control</p>	<p>The front sound is boosted.</p>	<p>The rear sound is boosted.</p>

Selectable illumination

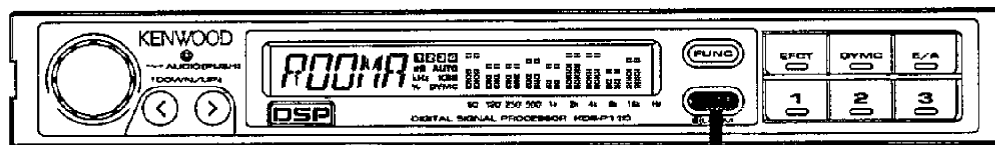

Illumination

Illumination color selection





Press the ILLUM button for more than a second.

Every time the ILLUM button is pressed, the illumination switches between green and orange.

Other feature section

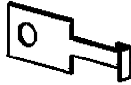
Accessories

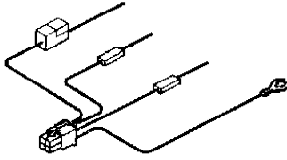
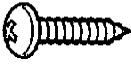
Installation

Part name	External view	Number of items
Panel frame		1
Side bracket		2
Bracket		2
Wiring harness		1
Self-tapping screw ($\phi 4 \times 16$)		4
Flat head screw (M4 \times 6)		2
Washer assembly screw (M4 \times 8)		3

Installation procedure

1. Remove the ignition key and disconnect the negative (-) terminal of the battery to prevent short circuits.
2. Connect the input and output cables of the units.
3. Connect the ground cable and power supply cable of the wiring harness in the order listed.
4. Connect the wiring harness connectors to the unit.
5. Install the unit in the car.
6. Connect the negative (-) terminal of the battery.
7. Press the Reset button.

▲ CAUTION

- If the fuse blows, check cables for shorts, then replace the fuse with one of the same rating.
- Check that no unconnected cables or connectors are touching the car body. Do not remove caps from unconnected cables or connectors to prevent short circuits.
- After installation, check that the brake lamps, wipers, and wipers work properly.

Connections

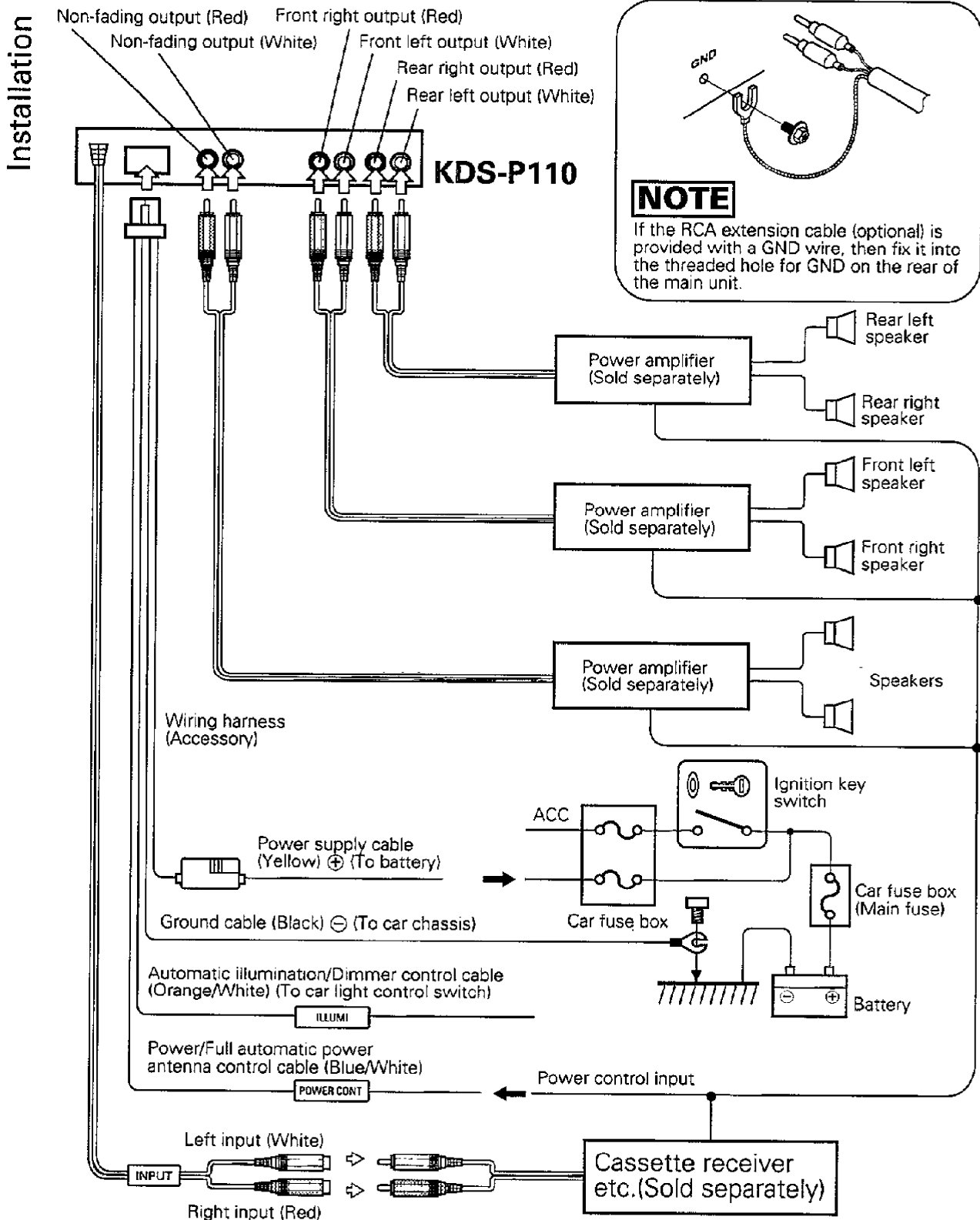

Installation

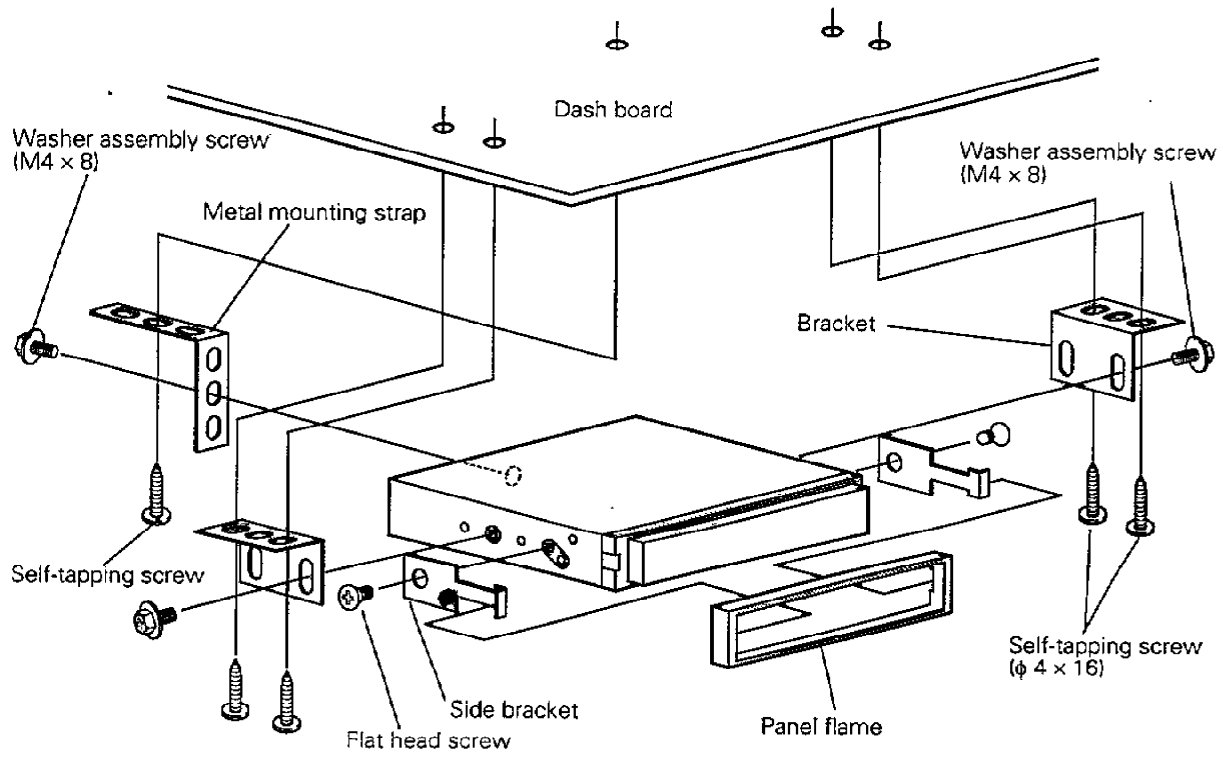

Installation

Troubleshooting guide

Often, what appears to be a malfunction is due to user error. Before calling for service please consult the following table.

Troubleshooting guide

Symptom	Cause	Remedy
No power.	The power is off the center unit.	Turn the center unit on.
	The center unit is set all mode stand by.	End all mode stand by on the center unit.
	The power cord fuse has blown.	Check for a short in the power cord, then replace the fuse.
No sound.	The speaker cord, system power ,input, or output cords are not connected properly.	Follow the instructions in this manual and connect correctly.
	The volume level of the center unit is low.	Increase the volume of the center unit.
	The fader or balance adjustment is skewed to one side.	Reset the fader or balance adjustment.
No DSP effect.	You have a 2-speaker system.	Install a 4-speaker system (front and rear)
	The front and rear output are reversed.	Follow the instructions to connect correctly.
	The left and right speakers are reversed.	Follow the instructions to connect correctly.
	The speaker's plus (+) and minus(-) are reversed.	Follow the instructions to connect correctly.
	The fader or balance adjustment is skewed.	Set the fader and balance to the center position.
	The effect level is zero.	Set the effect level to 80%.
Memory is wiped out when the engine stops.	The Power supply lead is not connected.	Follow the instructions to connect correctly.

Specifications

Specifications subject to change without notice.

Specifications

DSP section

A/D converter	64 times over sampling $\Delta\Sigma$ modulation with 5th order noise shaper
Digital filter (D/A)	16 times over sampling 18 bit 2nd order noise shaper
Frequency response	20 Hz ~ 20 kHz (± 1 dB)
Total harmonic distortion	0.05 % (1 kHz)
Signal to Noise ratio	100 dB
Dynamic range	100 dB

Audio section

Input impedance	10 k ohms
Preout level	1000 mV (800 ohms)

General

Operating voltage	14.4 V (11 ~ 16 V allowable)
Current consumption	0.8 A
Dimensions (W x H x D)	178 x 25 x 140 mm 7 x 1 x 5-1/2 in.
Weight	0.9 kg (2.0 lb)

*An algorithm developed by the Toshiba Corporation is used as a part of the Dynamic range control.

KENWOOD
